



|              |  |
|--------------|--|
| Project Name |  |
| Type         |  |
| Part Number  |  |
| Quantity     |  |
| Notes        |  |

## Product Overview

The Ridge RG4 is a modern and stylish surface-mounted wall light that boasts a smooth, angular design, easily installed in a range of height and spacing configurations. Its design and wide beam distribution allows for greater spacing opportunities, maintaining excellent uniformity levels to suit exterior and interior environments.

## Features

|                   |   |
|-------------------|---|
| Lumen Output      | 700 lm  |
| Power Consumption | 10 W  |
| Typical Lifetime  | 72,000 Hrs (L90 B10)  |
| Input Voltage     | International: 220-240 Vac, 50 Hz   North America: 120/277 Vac, 60 Hz               |
| IP Rating         | IP65  |
| IK Rating         | IK9   |
| Compliance        |  |
| Color Options     |  |

## Technology



## Specifications

### Hero - LS1282



### International

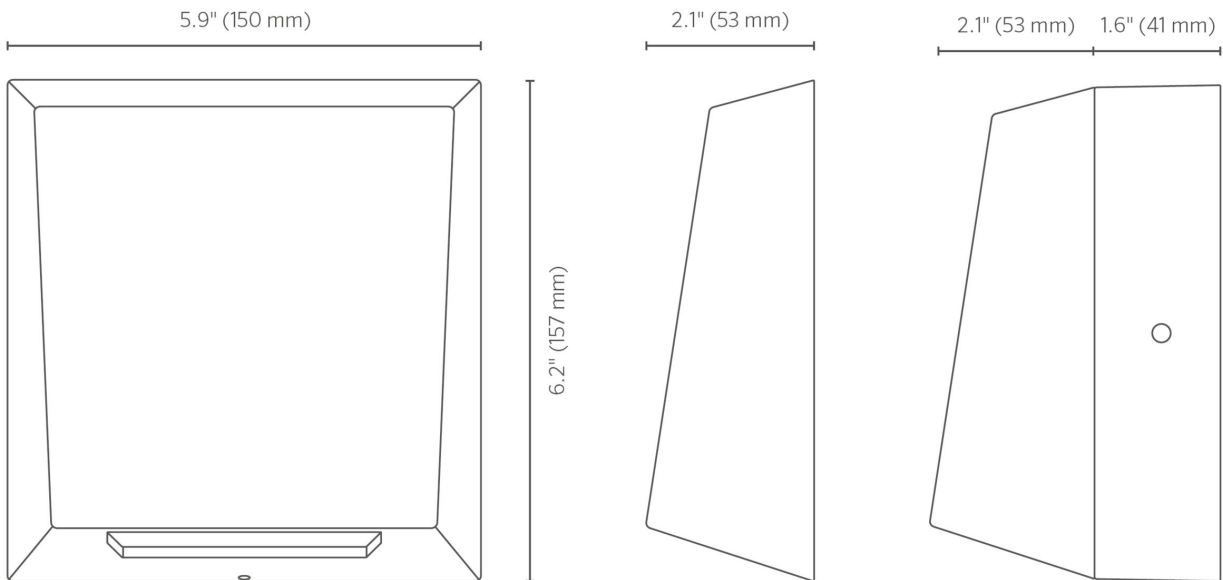

Side View With Wiring Back Box

## Configuration

For complete and up-to-date product options, configure the LS1282 using our online [product configurator](#).

|        |                   |              |             |               |         |        |
|--------|-------------------|--------------|-------------|---------------|---------|--------|
| LS1282 |                   |              |             |               |         |        |
| Code   | Power Consumption | Light Source | Beam Angles | Input Voltage | Control | Finish |

### Power Consumption

For all PowerSync Controlled Luminaires

10 W (10D)

### Light Source

**Static White (827)**  
2,700 K (80 CRI, 3 SDCM)



**Static White (830)**  
3,000K (80 CRI, 3 SDCM)



**Static White (840)**  
4,000 K (80 CRI, 3 SDCM)



### Beam Angles

Published angles may vary slightly to photometric data. Please refer to IES files where relevant.

**Wide (MD)**  
100° x 75°

### Input Voltage

**220 to 240 Vac, 50 Hz (01)**  
Line Voltage













### Control

DALI (DL)

## Finish

Custom powder coat colours are available. Please consult factory.

- |   |   |   |   |   |   |
|---|---|---|---|---|---|
| <input type="checkbox"/> <b>Black (BL)</b><br>RAL9004 from RAL<br>Classic collection<br>(formerly CB)   |  | <input type="checkbox"/> <b>Anthracite Gray (AG)</b><br>RAL7016 from RAL<br>Classic collection                |  | <input type="checkbox"/> <b>Basalt Gray (BT)</b><br>RAL7012 from RAL<br>Classic collection    |  |
| <input type="checkbox"/> <b>Graphite Gray (GH)</b><br>Graphite Gray   |  | <input type="checkbox"/> <b>Anodic Silver (SL)</b><br>RAL9006 from RAL<br>Classic collection<br>(formerly CS) |  | <input type="checkbox"/> <b>White (WT)</b><br>RAL9016 from RAL<br>Classic collection          |  |
| <input type="checkbox"/> <b>Dark Bronze (DB)</b><br>RAL8019 from RAL<br>Classic collection  |  | <input type="checkbox"/> <b>Latte (LT)</b><br>RAL7006 from RAL<br>Classic collection                          |  | <input type="checkbox"/> <b>Dark Aluminium (DA)</b><br>RAL9007 from RAL<br>Classic collection |  |
| <input type="checkbox"/> <b>Custom RAL (CC)</b><br>A one-off custom color setup fee applies. Click on 'More Info' button to add to your enquiry. Contact Lumascape for volume discount on set-up fee. |  |   |   |   |   |

## Accessories

### Mounting & Installation

Specify Separately

- Wiring Back Box (LS6336)**  
Surface mounted wiring back box.



---

### Custom Color

A one-off setup fee applies for each custom color per order. Add to your enquiry.

- Custom Color Setup Fee (Custom RAL Color)**  
Custom RAL colour setup fee

